

PLEASE NOTE!

The photos shown in this manual are for general instruction only. Your specific model may not be shown. Always refer to the parts list and exploded view drawing for your specific model when installing, disassembling or servicing your pump.

PRINCIPLE OF OPERATION

This ball check valve pump is powered by compressed air and is a 1:1 pressure ratio design. It alternately pressurizes the inner side of one diaphragm chamber, while simultaneously exhausting the other inner chamber. This causes the diaphragms, which are connected by a common rod, to move endwise. Air pressure is applied over the entire surface of the diaphragm, while liquid is discharged from the opposite side. The diaphragm operates under a balanced condition during the discharge stroke, which allows the unit to be operated at discharge heads over 200 feet (61 meters) of water head.

Since the diaphragms are connected by a common rod, secured by plates to the center of the diaphragms, one diaphragm performs the discharge stroke, while the other is pulled to perform the suction stroke in the opposite chamber.

For maximum diaphragm life, keep the pump as close to the liquid being pumped as possible. Positive suction head in excess of 10 feet of liquid (3.048 meters) may require a back pressure regulating device. This will maximize diaphragm life.

Alternate pressuring and exhausting of the diaphragm chamber is performed by means of an externally mounted, pilot operated, four-way spool type air distribution valve. When the spool shifts to one end of the valve body, inlet air pressure is applied to one diaphragm chamber and the other diaphragm chamber exhausts. When the spool shifts to the opposite end of the valve body, the porting of chambers is reversed. The air distribution valve spool is moved by an internal pilot valve which alternately pressurizes one side of the air distribution valve spool, while exhausting the other side. The pilot valve is shifted at each end of the diaphragm stroke by the diaphragm plate coming in contact with the end of the pilot valve spool. This pushes it into position for shifting of the air distribution valve.

The chambers are manifolded together with a suction and discharge check valve for each chamber, maintaining flow in one direction through the pump.

This SandPIPER pump differs from other SandPIPERs in that it utilizes four diaphragms instead of two. The two rod-connected diaphragms are the driver diaphragms, and the other two (outermost) diaphragms are the actual pumping diaphragms. Each driver diaphragm (of Neoprene or other elastomer), and the pumping diaphragm (of TFE), are separated by a chamber filled with liquid which transmits the reciprocating motion of the driver diaphragm to the pumping diaphragm. The pumping diaphragms, create the alternating suction and discharge action to each outer diaphragm chamber. The pumping diaphragms are the only ones in contact with the liquid being pumped.

INSTALLATION & START-UP

Locate the pump as close to the product being pumped as possible, keeping suction line length and number of fittings to a minimum. Do not reduce line size.

For installations of rigid piping, short flexible sections of hose should be installed between pump and piping. This reduces vibration and strain to the piping system. A Warren Rupp Tranquilizer® surge suppressor is recommended to further reduce pulsation in flow.

This pump was tested at the factory prior to shipment and is ready for operation. It is completely self-priming from a dry start for suction lifts of 10-15 feet (9-14 meters) or less. For suction lifts exceeding 15 feet of liquid, fill the chambers with liquid prior to priming.

⚠ IMPORTANT ⚠

Read these instructions completely, before installation and start-up. It is the responsibility of the purchaser to retain this manual for reference. Failure to comply with the recommendations stated in this manual will damage the pump, and void factory warranty.

⚠ WARNING ⚠

Take action to prevent static sparking. Fire or explosion can result, especially when handling flammable liquids. The pump, piping, valves, containers or other miscellaneous equipment must be grounded.

⚠ BEFORE OPERATION ⚠

Before pump operation, inspect all gasketed fasteners for looseness caused by gasket creep. Retorque loose fasteners to prevent leakage. Follow recommended torques stated in this manual.

⚠ CAUTION ⚠

This pump should not be applied in pumping applications where the driver liquid coming in contact with the pumped liquid would create a hazardous condition. This could happen in the case of a TFE pumping diaphragm failure. This diaphragm normally separates the two liquids. Do not operate this unit if it has been subjected to freezing temperatures. Because of the driver liquid used, possible diaphragm failure may result.



Fig. 1 Air Inlet

AIR SUPPLY

Air supply pressures cannot exceed 125 psi (8.61 bar). Connect the pump air inlet (see Figure 1) to an air supply of sufficient capacity and pressure required for desired performance. When the air line is solid piping, use a short length of flexible hose (not less than 3/4" [19mm] in diameter) between pump and piping to eliminate strain to pipes.

AIR INLET & PRIMING

For start-up, open an air valve approximately 1/2" to 3/4" turn. After the unit primes, an air valve can be opened to increase flow as desired. If opening the valve increases cycling rate, but does not increase flow rate, cavitation has occurred, and the valve should be closed slightly.

For the most efficient use of compressed air and the longest diaphragm life, throttle the air inlet to the lowest cycling rate that does not reduce flow.

A NOTE ABOUT AIR VALVE LUBRICATION

The SandPIPER pump's pilot valve and main air valve assemblies are designed to operate WITHOUT lubrication. This is the preferred mode of operation. There may be instances of personal preference, or poor quality air supplies when lubrication of the compressed air supply is required. The pump air system will operate with properly lubricated compressed air supplies. Proper lubrication of the compressed air supply would entail the use of an air line lubricator (available from Warren Rupp) set to deliver one drop of 10 wt., non-detergent oil for every 20 SCFM of air the pump consumed at its point of operation. Consult the pump's published Performance Curve to determine this.

It is important to remember to inspect the sleeve and spool set routinely. It should move back and forth freely. This is most important when the air supply is lubricated. If a lubricator is used, oil accumulation will, over time, collect any debris from the compressed air. This can prevent the pump from operating properly.

Water in the compressed air supply can create problems such as icing or freezing of the exhaust air causing the pump to cycle erratically, or stop operating. This can be addressed by using a point of use air dryer to supplement a plant's air drying equipment. This device will remove excess water from the compressed air supply and alleviate the icing or freezing problem.

ESADS: EXTERNALLY SERVICEABLE AIR DISTRIBUTION SYSTEM

Please refer to the exploded view drawing and parts list in the Service Manual supplied with your pump. If you need replacement or additional copies, contact your local Warren Rupp Distributor, or the Warren Rupp factory Literature Department at the number shown below. To receive the correct manual, you must specify the MODEL and TYPE information found on the name plate of the pump.

MODELS WITH 1" SUCTION/DISCHARGE OR LARGER, AND NON-METAL CENTER SECTIONS

The main air valve sleeve and spool set is located in the valve body mounted on the pump with four hex head capscrews. The valve body assembly is removed from the pump by removing these four hex head capscrews.

With the valve body assembly off the pump, access to the sleeve and spool set is made by removing a retaining ring (each end) securing the end cap on the valve body assembly. With the end caps removed, slide the spool back and forth in the sleeve. The spool is closely sized to the sleeve and must move freely to allow for proper pump operation. An accumulation of oil, dirt or other contaminants from the pump's air supply, or from a failed diaphragm, may prevent the spool from moving freely. This can cause the spool to stick in a position that prevents the pump from operating. If this is the case, the sleeve and spool set should be removed from the valve body for cleaning and further inspection.

Remove the spool from the sleeve. Using an arbor press or bench vise (with an improvised mandrel), press the sleeve from the valve body. Take care not to damage the sleeve. At this point, inspect the o-rings on the sleeve for nicks, tears or abrasions. Damage of this sort could happen during assembly or servicing. A sheared or cut o-ring can allow the pump's compressed air supply to leak or bypass within the air valve assembly, causing the pump to leak compressed air from the pump air exhaust or not cycle properly. This is most noticeable at pump dead head or high discharge pressure

⚠ WARNING ⚠

The weight of the air supply line end of the filter must be supported by some means other than the air valve cap. Failure to provide support may result in damage to the pump.

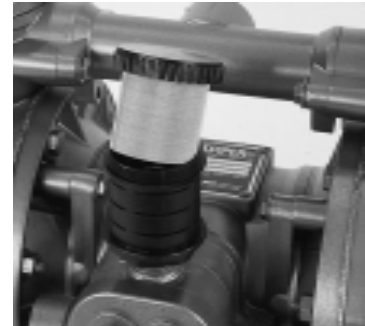

Fig. 2 Exhaust muffler

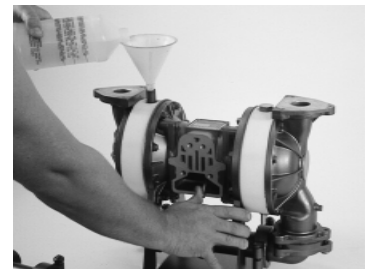

Fig. 3 Filling the driver chamber

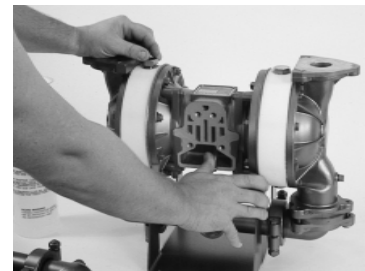

Fig. 4 Purge air in pump by moving diaphragm rod.

⚠ DANGER ⚠

Before doing any maintenance on the pump, be certain all pressure is completely vented from the pump, suction, discharge, piping, and all other openings and connections. Be certain the air supply is locked out or made non-operational, so that it cannot be started while work is being done on the pump. Be certain that approved eye protection and protective clothing are worn at all times in the vicinity of the pump. Failure to follow these recommendations may result in serious injury or death.

conditions. Replace any of these o-rings as required or set up a routine, preventive maintenance schedule to do so on a regular basis. This practice should include cleaning the spool and sleeve components with a safety solvent or equivalent, inspecting for signs of wear or damage, and replacing worn components.

To re-install the sleeve and spool set, lightly lubricate the o-rings on the sleeve with an o-ring assembly lubricant or lightweight oil (such as 10 wt. air line lubricant). Re-install one end cap, and retaining ring on the valve body. Using the arbor press or bench vise that was used in disassembly, carefully press the sleeve back into the valve body, without shearing the o-rings. Re-install the spool, opposite end cap and retaining ring on the valve body. After inspecting and cleaning the gasket surfaces on the valve body and intermediate, re-install the valve body on the pump using new gaskets. Tighten the four hex head capscrews evenly and in an alternating cross pattern, at 150 in./lbs. (16.94 Newton meters).

AIR EXHAUST

If a diaphragm fails, the pumped liquid or fumes can enter the air end of the pump, and be exhausted into the atmosphere. When pumping hazardous or toxic materials, pipe the exhaust to an appropriate area for safe disposition.

This pump can be submerged if materials of construction are compatible with the liquid. The air exhaust must be piped above the liquid level. Piping used for the air exhaust must not be smaller than 1" (2.54 cm). Reducing the pipe size will restrict air flow and reduce pump performance. When the product source is at a higher level than the pump (flooded suction), pipe the exhaust higher than the product source to prevent siphoning spills.

Freezing or icing of the air exhaust can occur under certain temperature and humidity conditions. Use of an air dryer should eliminate most icing problems. Check the exhaust periodically for build-up of ice or contaminants (see Figure 2).

BETWEEN USES

When used for materials that tend to settle out or transform to solid form, the pump should be completely flushed after each use, to prevent damage. Product remaining in the pump between uses could dry out or settle out. This could cause problems with valves and diaphragms at re-start. In freezing temperatures, the pump must be drained between uses in all cases.

FILLING OF DRIVER CHAMBER WITH LIQUID

The driver chambers are filled at the factory with water.

If you need to substitute another liquid to prevent system contamination, first consult the factory for chemical compatibility with pump construction.

Follow the steps listed below to replace the liquid in the pump after disassembly or liquid loss:

1. Filling is accomplished through the pipe plugs at the top of the liquid driver chamber (see Figure 3).
2. After the driver fluid has been emptied from the pump, the driver diaphragms will naturally come to center.
3. Remove the entire discharge manifold assembly exposing the ports in the outer diaphragm chambers.
4. Fill either side with 600 ml. (20.44 fl. oz.) by volume with the driver liquid. It is imperative that the driver liquid chambers be filled with the correct amount of driver liquid as too little or too much will cause premature diaphragm failure and erratic pumping.
5. After filling with the proper amount of liquid, if the liquid does not come to the top of the fill hole, pressure should be applied to the PTFE diaphragm with a blunt tool through the discharge material flow port in the outer chamber until it does come to the top (see Figure 4). To facilitate this filling, a taper punch can be used in the hole of the rod to manually shift the pump.
6. When the driver fluid rises to the top of the fill plug hole, screw the boss plug, with o-ring installed, into the chamber (see Figure 5). (Do not overtighten.) Remember to keep pressure on the PTFE diaphragm until the boss plug is tight to prevent air from drawing back into the chamber.
7. Filling the opposite side is accomplished in the same manner as described in 5 and

CAUTION

In the event of diaphragm rupture, pumped material may enter the air end of the pump, and be discharged into the atmosphere. If pumping a product which is hazardous or toxic, the air exhaust must be piped to an appropriate area for safe disposition.

CAUTION

Do not use a wrench on the diaphragm rod. Flaws on the surface may damage bearings and seals.

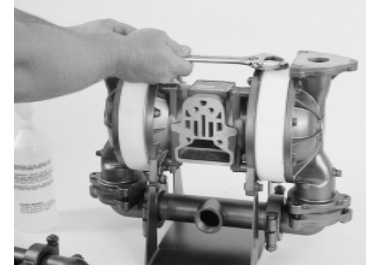

Fig. 5 Tighten the boss plug.

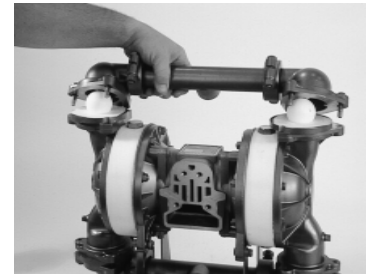

Fig. 6 Ball check valves



Fig. 7 Diaphragm installation



Fig. 8 Torquing the air inlet capscrews

CHECK VALVE SERVICING

Need for inspection or service is usually indicated by poor priming, unstable cycling, reduced performance or the pump's cycling but not pumping.

Remove the six flange bolts securing the inlet and outlet flanges to the manifold. Inspect the surfaces of both check valve and seat for wear or damage that could prevent proper sealing. If pump is to prime properly, valves must seat air tight (see Figure 6).

DIAPHRAGM SERVICING

Driver Diaphragms:

Drain the driver diaphragm chamber by removing the boss plug on the underside of the driver chamber. **NOTE:** This is also the part used for leak detector probes. Remove twelve bolts securing the two manifolds to the chambers. Remove eight bolts securing the diaphragm chamber. This permits inspection of the TFE diaphragm and the driver diaphragm. Loosen the plate which secures the diaphragm and plate to the rod by keeping the diaphragm engaged with the inner diaphragm chamber. Insert two or three capscrews through the bolt holes so the diaphragm cannot rotate when loosening. The diaphragm plates, diaphragm and bumper will now come off the assembly. Repeat all actions if the other diaphragm needs to be inspected or replaced.

NOTE: See "Filling of Driver Chamber with Liquid" for the correct procedure to recharge the pump for operation.

Reassembly is the reverse of the tear down. During reassembly, be sure the rubber bumper is on the rod on each side. Install the diaphragm with the natural bulge to the outside as marked on the diaphragm. Be sure that the large radius side of each plate is toward the diaphragm. Place the sealing washer between the inner diaphragm plate and the end of the rod. Tighten the plate to approximately 25 ft. lbs. (3.456 pounds/sq. cm.). Torque while allowing the diaphragm to turn freely with the plate. Hold the opposite side with a wrench on the plate to prevent rotation of the rod. If the opposite chamber is assembled, this will not be necessary.

When reassembling the outer chambers and the manifold, the bolts securing the manifold flange to the chamber should be snugged prior to tightening the manifold flange. Finish tightening the manifold flange bolts after the chamber bolting is secured.

PILOT VALVE

The pilot valve assembly is accessed by removing the main air distribution valve body from the pump and lifting the pilot valve body out of the intermediate housing (see Figure 9).

Most problems with the pilot valve can be corrected by replacing the o-rings. Always grease the spool prior to inserting it into the sleeve. If the sleeve is removed from the body, reinsertion must be at the chamfered side. Grease the o-rings to slide the sleeve into the valve body. Securely insert the retaining ring around the sleeve. When reinserting the pilot valve, push both plungers (located inside the intermediate bracket) out of the path of the pilot valve spool ends to avoid damage.

PILOT VALVE ACTUATOR

Bushings for the pilot valve actuators are held in the inner chambers with retaining rings. An o-ring is behind each bushing. If the plunger has any sideways motion check o-rings and bushings for deterioration or wear. The plunger may be removed for inspection or replacement. First remove the air distribution valve body and the pilot valve body from the pump. The plungers can be located by looking into the intermediate. It may be necessary to use a fine piece of wire to pull them out. The bushing can be turned out through the inner chamber by removing the outer chamber assembly. Replace the bushings if pins have bent (see Figure 10 and Figure 11).

SERVICE INSTRUCTIONS: TROUBLE SHOOTING

1. Pump will not cycle

A. Check to make sure the unit has enough pressure to operate and that the air inlet valve is open.

B. Check the discharge line to insure that the discharge line is neither closed nor blocked.

C. If the spool in the air distribution valve is not shifting, check the main spool. It must slide freely.

⚠ IMPORTANT ⚠

This pump is pressurized internally with air pressure during operation. Always make certain that all bolting is in good condition and that all of the correct bolting is reinstalled during assembly.

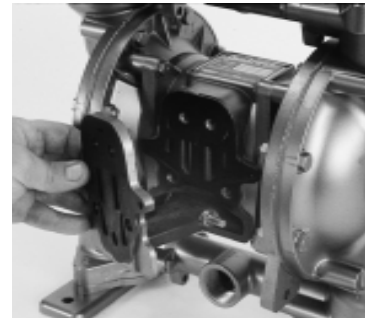

Fig. 9 Pilot valve removal



Fig. 10 Pilot valve spool and o-rings



Fig. 11 Bushings and o-rings

D. Excessive air leakage in the pump can prevent cycling. This condition will be evident. Air leakage into the discharge line indicates a ruptured diaphragm. Air leakage from the exhaust port indicates leakage in the air distribution valve. See further service instructions.
E. Blockage in the liquid chamber can impede movement of diaphragm.

2. Pump cycles but will not pump

A. Suction side of pump pulling in air. Check the suction line for air leaks and be sure that the end of the suction line is submerged. Check flange bolting. Check valve flanges and manifold to chamber flange joints.

B. Make certain the suction line or strainer is not plugged. Restriction at the suction is indicated by a high vacuum reading when a vacuum gauge is installed in the suction line.

C. Check valves may not be seating properly. To check, remove the suction line and cover the suction port with your hand. If the unit does not pull a good suction (vacuum), the check valves should be inspected for proper seating.

D. Static suction lift may be too high. Priming can be improved by elevating the suction and discharge lines higher than the check valves and pouring liquid into the unit through the suction inlet. When priming at high suction lifts or with long suction lines operate the pump at maximum cycle rate.

E. Incorrect driver fluid level or air has not been properly purged.

3. Low performance

A. Capacity is reduced as the discharge pressure increases, as indicated on the performance curve. Performance capability varies with available inlet air supply. Check air pressure at the pump inlet when the pump is operating to make certain that adequate air supply is maintained.

B. Check vacuum at the pump suction. Capacity is reduced as vacuum increases. Reduced flow rate due to starved suction will be evident when cycle rate can be varied without change in capacity. This condition will be more prevalent when pumping viscous liquids. When pumping thick, heavy materials the suction line must be kept as large in diameter and as short as possible, to keep suction loss minimal.

C. Low flow rate and slow cycling rate indicate restricted flow through the discharge line. Low flow rate and fast cycling rate indicate restriction in the suction line or air leakage into suction.

D. Unstable cycling indicates improper check valve seating on one chamber. This condition is confirmed when unstable cycling repeats consistently on alternate exhausts. Cycling that is not consistently unstable may indicate partial exhaust restriction due to freezing and thawing of exhaust air. Use of an anti-freeze lubricant in an air line lubricator should solve this problem.

E. Incorrect driver fluid level or air has not been properly purged.

For additional information, see the Warren Rupp Trouble shooting Guide.

WARRANTY

This pump is warranted for a period of five years against defective material and workmanship. Failure to comply with the recommendations stated in this manual voids all factory warranty.

©2002 Warren Rupp, Inc. All rights reserved.



®Warren Rupp, SandPIPER and Tranquilizer are registered tradenames of Warren Rupp, Inc.

®Neverseize is a registered tradename of Loctite.

Printed in U.S.A.

ITEM NO.	PART NUMBER	DESCRIPTION	TOTAL RQD.	Repair Parts shown in bold face (darker) type are more likely to need replacement after extended periods of normal use. The pump owner may prefer to maintain a limited inventory of these parts in his own stock to reduce repair downtime to a minimum.
1	095-051-551	Body, Spool Valve	1	<p>IMPORTANT: When ordering repair parts always furnish pump model number, serial number and type number.</p> <p>MATERIAL CODES The Last 3 Digits of Part Number</p> <hr/> <p>000...Assembly, sub-assembly; and some purchased items 010...Cast Iron 015...Ductile Iron 025...Music Wire 080...Carbon Steel, AISI B-1112 100...Alloy 20 110...Alloy Type 316 Stainless Steel 112...Alloy "C" 114...303 Stainless Steel 115...301/302/304 Stainless Steel 120...416 Stainless Steel (Wrought Martensitic) 148...Hardcoat Anodized Aluminum 150...6061-T6 Aluminum 151...6063-T6 Aluminum 154...Almag 35 Aluminum 155 or 156...356-T6 Aluminum 157...Die Cast Aluminum Alloy #380 159...Anodized Aluminum 162...Brass, Yellow, Screw Machine Stock 170...Bronze, Bearing Type, Oil Impregnated 180...Copper Alloy 330...Plated Steel 331...Chrome Plated Steel 332...Electroless Nickel Plated 335...Galvanized Steel 356...Injection Molded Hytrel 357...Rupplon (Urethane Rubber) 358...E.P.D.M. (Food Grade) 359...Polyurethane 360...Buna-N Rubber. Color coded: RED 363...Viton (Fluorel). Color coded: YELLOW 364...E.P.D.M. Rubber. Color coded: BLUE 365...Neoprene Rubber. Color coded: GREEN 366...Food Grade Nitrile. Color coded: WHITE 375...Fluorinated Nitrile 405...Cellulose Fibre 408...Cork and Neoprene 425...Compressed Fibre 440...Vegetable Fibre 500...Delrin 500 501...Delrin 570 520...Injection Molded PVDF, Natural Color, Food Grade/USDA Acceptable 541...Nylon, glass filled 550...Polyethylene 551...Polypropylene 552...Unfilled Polypropylene 555...PVC 570...Rulon II 580...Ryton 590...Valox 600...PTFE (virgin material) Tetrafluoroethylene (TFE) 603...Blue Gylon 604...Teflon, Diaphragm 610...PTFE Encapsulated Silicon 611...PTFE Encapsulated Viton 632...Neoprene Rupplon 633...Viton/PTFE 634...EPDM/PTFE 636...White Nitrile/PTFE</p> <p>Delrin, Viton and Hytrel are registered tradenames of E.I. DuPont. Gylon is a registered tradename of Garlock, Inc. Nylatron is a registered tradename of Polymer Corporation. Rulon II is a registered tradename of Dixon Industries Corp. Rupplon and SandPIPER are registered tradenames of Warren Rupp, Inc. Ryton is a registered tradename of Phillips Chemical Company. Valox is a registered tradename of General Electric Company.</p>
2	031-083-000	Sleeve & Spool Set w/Pins	1	
3	560-058-360	O-Ring	8	
4	165-078-147	Cap, End	2	
5	675-043-115	Ring, Retaining	2	
6	165-042-157	Cap, Valve Body	1	
	165-042-551*	Cap, Valve Body	*1	
7	360-056-360	Gasket	1	
8	360-057-360	Gasket	1	
9	360-058-360	Gasket	1	
10	095-074-000	Assembly, Pilot Valve**	1	
10-A	095-071-551	Valve Body	1	
10-B	755-025-000	Sleeve (without O-Ring)	1	
10-C	560-033-360	O-Ring (Sleeve)	4	
10-D	775-014-000	Spool (without O-Ring)	1	
10-E	560-023-360	O-Ring (Spool)	4	
10-F	675-037-080	Retaining Ring	1	
11	170-063-115	Capscrew, Hex Head	1	
12	901-035-115	Washer, Flat	1	
13	542-001-115	Nut, Square	1	
14	170-033-115	Capscrew, Hex Head	4	
15	901-005-115	Washer, Flat	4	
16	170-043-115	Capscrew, Hex Head	6	
	170-018-115*	Capscrew, Hex Head	*6	
17	114-007-157	Bracket, Intermediate	1	
	114-012-010*	Bracket, Intermediate	*1	
18	196-042-157	Chamber, Inner	1	
	196-090-010*	Chamber, Inner	*1	
19	196-043-157	Chamber, Inner	1	
	196-084-010*	Chamber, Inner	*1	
20	560-040-360	O-Ring	2	
21	560-001-360	O-Ring	2	
22	135-034-506	Bushing	2	
23	675-042-115	Ring, Retainer	2	
24	620-015-114	Plunger, Actuator	2	
25	132-022-360	Bumper	2	
26	070-012-170	Bearing, Sleeve	2	
27	720-010-375	Seal, U-Cup	2	
28	196-057-110	Chamber, Outer	2	
29	901-012-180	Washer, Sealing	2	
30	115-078-115	Bracket, Mounting	1	
31	675-040-360	Ring, Sealing	2	
32	685-039-120	Rod, Diaphragm	1	
33	132-019-360	Bumper	2	
34	612-101-110	Plate, Outer Diaphragm	2	
35	612-022-330	Plate, Inner Diaphragm	2	

ITEM NO.	PART NO.	DESCRIPTION	TOTAL RQD.
36	286-040-604	Diaphragm	2
37	722-045-600	Seat, Valve	4
38	050-024-600	Ball, Check Valve	4
39	518-062-110	Manifold, Suction	1
40	518-063-110	Manifold, Discharge	1
41	312-052-110	Elbow, Suction	2
42	312-051-110	Elbow, Discharge	2
43	361-005-600	Gasket Seal, Suction	2
44	361-006-600	Gasket Seal, Discharge	2
45	200-037-115	Clamp, Suction, Assembly (includes nuts & bolts)	2
46	200-036-115	Clamp, Discharge, Assembly (includes nuts & bolts)	2
47	170-029-115	Capscrew, Hex Head	12
48	170-041-115	Capscrew, Hex Head	16
49	545-004-115	Nut, Hex Head	20
50	170-044-115	Capscrew, Hex Head	4
51	900-004-115	Washer, Lock	4
52	901-039-115	Washer, Flat	12
53	618-003-330	Pipe Plug	2
54	312-044-555	45° Elbow	1
55	538-025-555	Nipple, Close	1
56	530-018-000	Muffler, Exhaust	1
58	807-048-330	Stud	2
59	196-077-600	Chamber, Driver	2
60	618-025-110	Plug, Boss	4
	618-025-110	Plug, Boss (Use with electronic leak detector)	2
61	560-078-611	O-Ring	4
	560-078-611	O-Ring (Use with electronic leak detector)	2
62	286-008-365	Diaphragm	2
63	286-015-604	Diaphragm—Overlay	2
64	170-020-115	Capscrew	4
65	170-022-115	Capscrew	4
66	900-005-115	Washer, Lock	8
67	545-005-337	Nut, Hex Head	8
68	901-035-115	Washer, Flat	7
	901-035-115*	Washer, Flat	*1
	900-005-115*	Washer, Lock	*6
69	132-028-552	Bumper, Spool	2
71	210-008-330	Clip, Safety	1
72	560-029-360	O-ring	2
73	618-003-330	Pipe Plug	3

NOTE:
 When electronic leak detector is used with this model pump, the probes must be fitted into special boss plugs. Order one kit 475-098-000 for each pump. 

Not Shown:

031-111-000	Valve Body Assembly (Includes items 1, 2, 3, 4, 5, 69, 71 & 72)	1
-------------	---	---

* Use for Models with cast iron air end.

** Available **only** in kit form. Order 031-060-000 which also includes Items 7, 8, 9, 24 and 25.

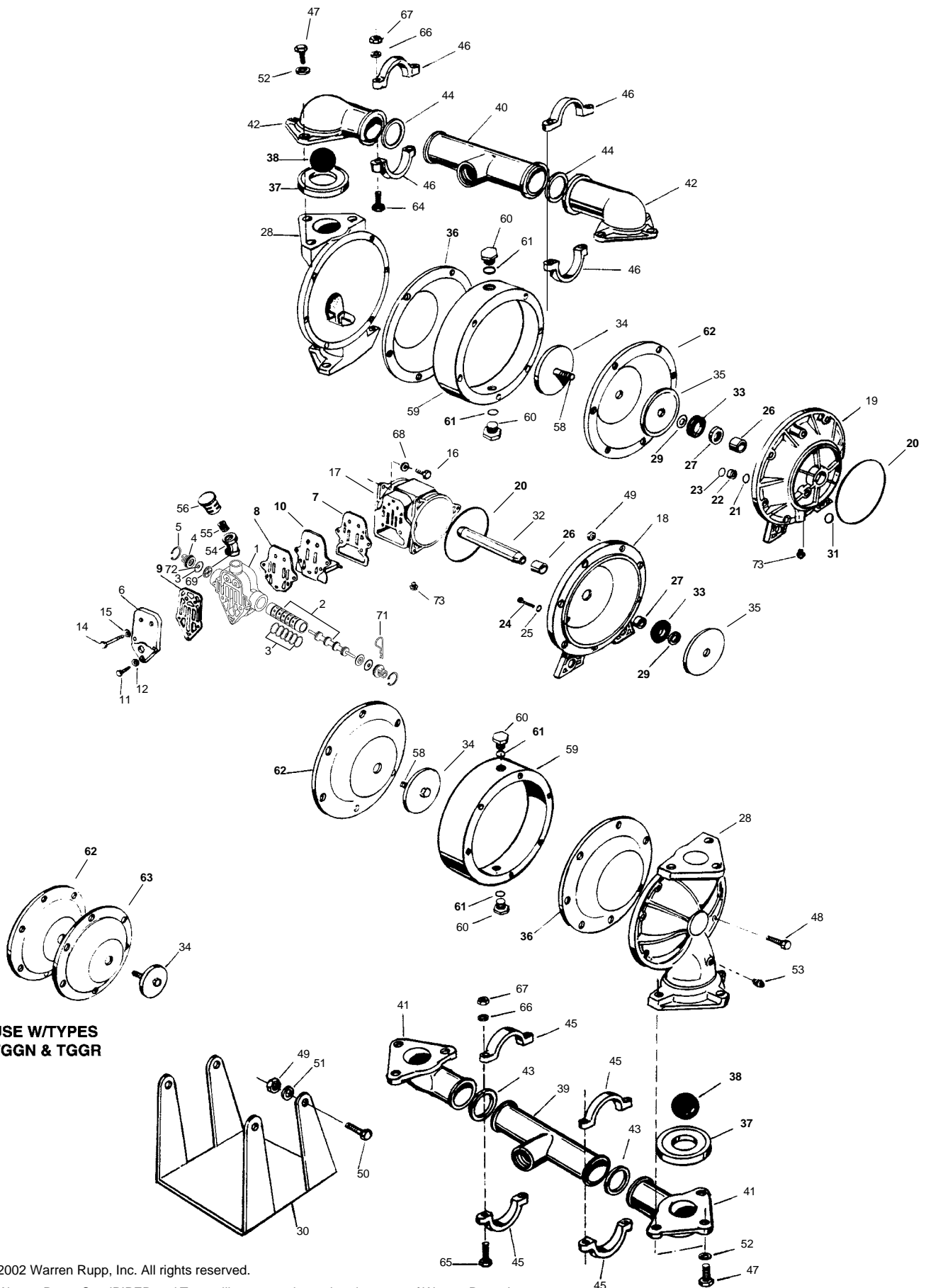

**USE W/TYPES
TGGN & TGGR**

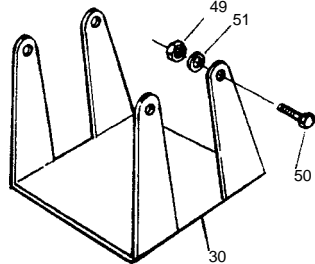

©2002 Warren Rupp, Inc. All rights reserved.

©Warren Rupp, SandPIPER and Tranquilizer are registered tradenames of Warren Rupp, Inc.